

Optical Fiber Cleaver FC-6

Operation Manual

IMPORTANT SAFETY PRECAUTIONS

This product has been designed and manufactured to assure personal safety. Improper use can result in bodily injury and serious damage to the fiber cleaver. Please read and observe all warnings instructions given in this operation manual.



- Do not disassemble or lubricate any parts of the cleaver. Doing so could cause serious damage to the cleaver.
- The FC-6 is a precision tool. Do not impact the cleaver by hitting or dropping it. Doing so may cause personal injury and loss of cleaving performance.
- Glass fiber fragments are extremely sharp. Handle with care. Wear safety glasses at all times during cleaving operation for protection from glass fibers.
- Dispose of glass fiber fragments properly.
- The blade of the cleaver is extremely sharp. Do not touch it with bare hands.
- Do not impact the top clamp lever. Doing so could cause damage to the cleaver and loss of cleaving performance.
- If the cleaver is damaged or a problem occurs, please contact our maintenance service center.

1. General

Specification

	FC-6M / FC-6M-C
Cladding Diameter	125 μ m
Fiber Count	Single fiber (0.25 & 0.9mm)
Coating Diameter	Up to 12-fiber ribbon
Cleave length	10mm
Dimensions	FC-6M: 63(W)x76(D)x63(H)mm FC-6M-C: 100(W)x81(D)x63(H)mm
Weight	FC-6M: Approx. 380g FC-6M-C: Approx. 420g

	FC-6S / FC-6S-C
Cladding Diameter	125 μ m
Fiber Count	Single fiber (0.25 & 0.9mm)
Coating Diameter	Up to 12-fiber ribbon
Cleave length	9~16mm (0.25mm) 10~16mm (0.9mm)
Dimensions	FC-6S: 63(W)x76(D)x63(H)mm FC-6S-C: 100(W)x81(D)x63(H)mm
Weight	FC-6S: Approx. 380g FC-6S-C: Approx. 420g

Standard package

	FC-6M	FC-6M-C	FC-6S	FC-6S-C
Optical Fiber Cleaver FC-6	1 pc	1 pc	1 pc	1 pc
Carrying case	1 pc	1 pc	1 pc	1 pc
Operation Manual	1 pc	1 pc	1 pc	1 pc

Optional accessories / Consumables

FC-6M	FC-6M-C
Single fiber adapter: AP-FC-6M Fiber off-cut collector: CU-FC6 Replacement blade: FCP-20BL	
FC-6S	FC-6S-C
Fiber off-cut collector: CU-FC6 Replacement blade: FCP-20BL	

2. Structure

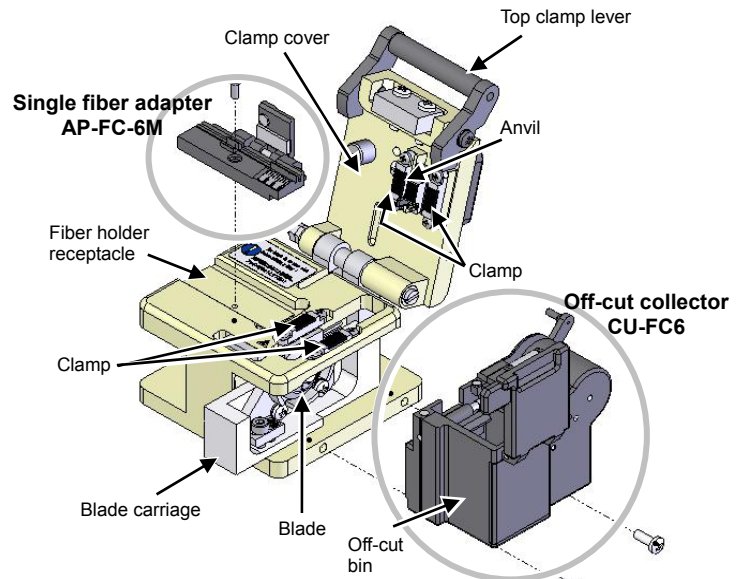

< Fiber cleaver FC-6M(-C)/6S(-C) >

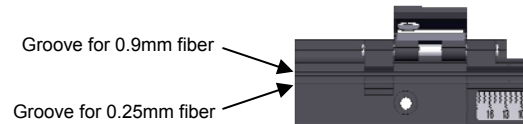

< Single fiber adapter AP-FC-6M >

3. Operating procedures

FC-6S(-C)

- Open the top clamp lever and the lid of the single fiber adapter. The blade carriage should be in the forward position.

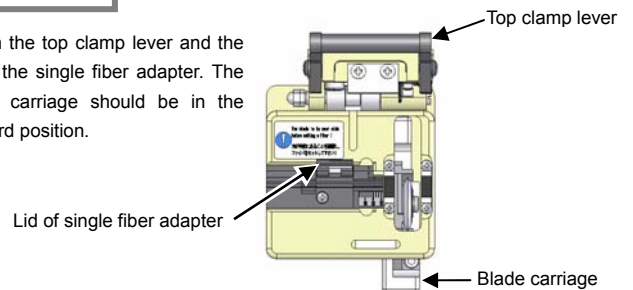

- Lower the fiber straight into the correct V-groove with the end of the fiber coating (e.g. if the cleave length is 16mm) at the 16mm mark on the ruler.

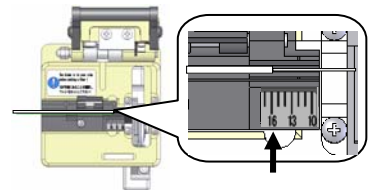

- Close the lid of the single fiber adapter.

- Lower the top clamp lever. Slide the blade carriage to the rear of the cleaver. The fiber will be cleaved.

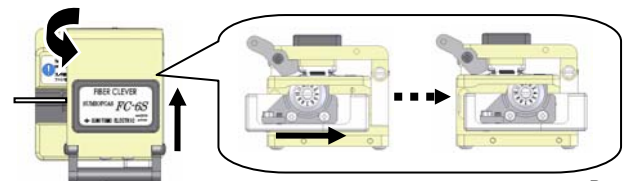

- Open the top clamp lever. Then open the lid of the single fiber adapter and lift the newly cleaved fiber. Lift the off-cut and dispose it properly. (The FC-6S-C automatically collects an off-cut in the off-cut collector.)

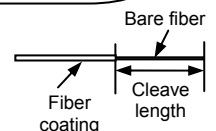

FC-6M(-C)

- 1: Open the top clamp lever. The blade carriage should be in the forward position.

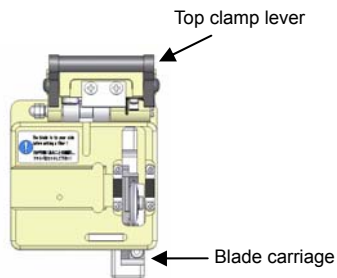

- 2: Place the fiber holder in the cleaver. Place the edge of the fiber holder against the edge of the fiber holder receptacle.

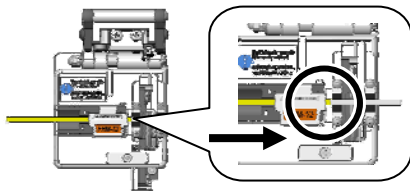

- 3: Lower the top clamp lever. Slide the blade carriage to the rear of the cleaver. The fiber will be cleaved.

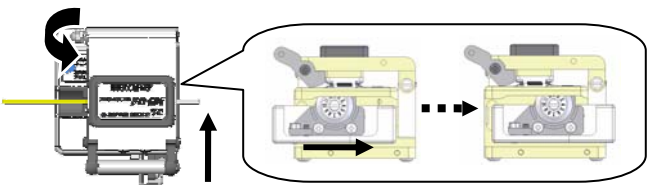

- 4: Open the top clamp lever. Remove the fiber holder from the cleaver. Lift the off-cut and dispose it properly. (The FC-6M-C automatically collects an off-cut in the off-cut collector.)

4. Maintenance

Cleaning

To keep excellent cleaving quality, cleaning must be performed after use.

Clean the blade edge, the rubber pad of the clamp and the anvil with a cotton swab moistened with isopropyl alcohol.

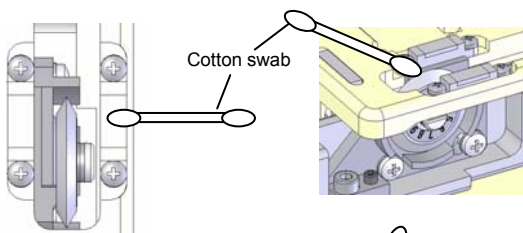

Clean the fiber holder receptacle and the grooves of the single fiber adapter, too.

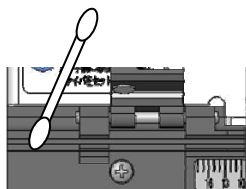

- Dust on the blade edge or the clamp might cause loss of cleaving performance or poor quality of fiber end face.
- Do not clean them with any other kind of chemicals.
- If the top clamp lever is closed leaving an off-cut fiber on the clamp, the rubber pad of the clamp will have a trace of the fiber, causing loss of cleaving performance or poor quality of fiber end face.

Blade position change

As the number of the cleave's increases, a symptom that fiber cannot be cleaved or cracks will occur. If such symptom continues to appear, the blade position is worn out. Rotate the blade according to the following procedures and use a new blade position.

[Reference] 1,000 fibers per position

- 1: Loosen the blade setscrew. Note that the blade setscrew is a slotted screw.

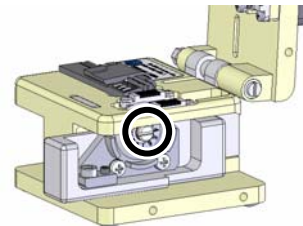

- 2: Rotate the blade to the next position by pressing its side or edge with a cotton swab.

Rotate the blade in the direction indicated by the arrow.

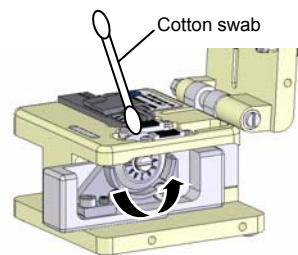

- Do not rotate the blade with hands.
- Do not rotate the blade with metallic tweezers. Doing so may damage the blade.

- 3: Tighten the blade setscrew. [Reference] Optimum torque: Approx. 0.98N-m (10kgf-cm)

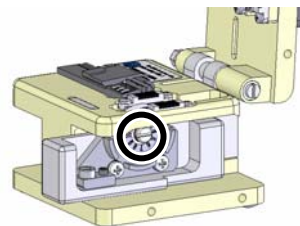

- Do not over-tighten the blade setscrew. The screw will get worn out.

- 4: Try and cleave the fiber. Make visual check of the fiber end face with the splicer. If the fiber end face is poor, adjust the blade height. (Refer to "Blade height adjustment".)

Blade height adjustment

(0: For FC-6S(M)-C, remove the off-cut collector first.)

- 1: Loosen the 2 cross head screws.

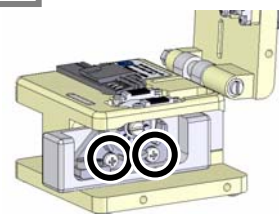

- 2: Loosen the blade height locking screw.

Put a Hex driver (US) or Allen key (UK) here.

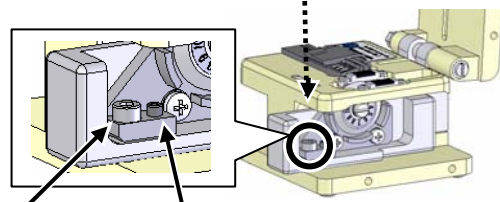

Blade height locking screw

Blade height adjustment screw

3: Place a mechanical pencil lead or a light stick on the clamps. Slide the blade carriage back and forth and turn the blade height adjustment screw. The point where the lead barely touches the edge of the blade is a **reference point (0 μ m)**.

☑ Tips

- To make the blade higher, turn the blade height adjustment screw clockwise.
- To make the blade lower, turn the blade height adjustment screw anti-clockwise. (Turn the screw while pushing the blade down with a cotton swab.)

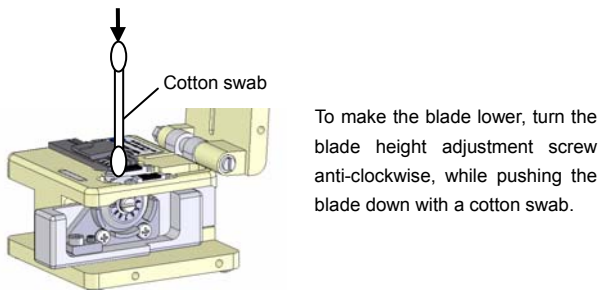
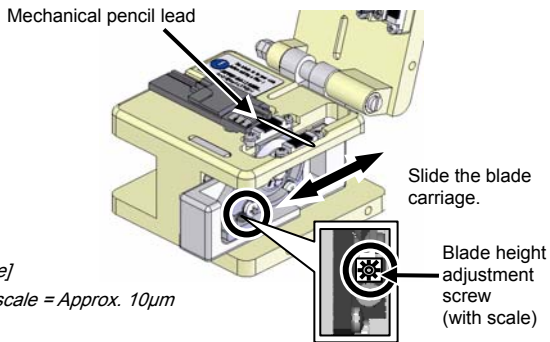

4: Turn the blade height adjustment screw clockwise by more 4 to 6 marks from the reference point.

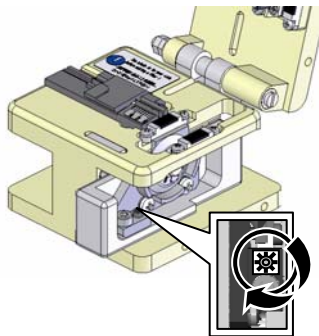

- Do not make the blade too high. Doing so will damage the anvil and increases the chipped fiber ends.

5: Tighten the blade height locking screw.
[Reference] Optimum torque: Approx. 0.59N·m (6kgf·cm)

6: Tighten the 2 cross head screws.
[Reference] Optimum torque: Approx. 0.98N·m (10kgf·cm)

Blade replacement

(0: For FC-6S(M)-C, remove the off-cut collector first.)

1: Unscrew the blade setscrew.

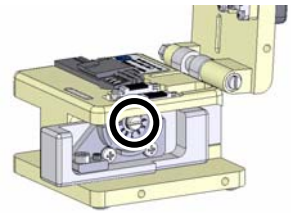

2: Remove the blade with tweezers.

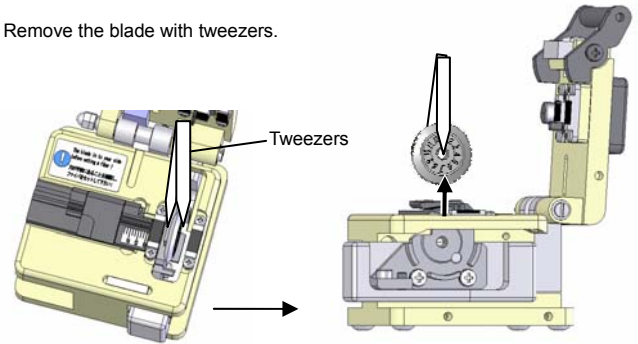

- The edge of a blade is manufactured precisely. If the edge is hit against metallic objects, it will crack, resulting in poor cleaving performance. Handle with care.
- When using metallic tweezers, be careful not to damage the blade.
- Do not touch the blade with hands. Use gloves.
- Dispose of the old blade properly.

3: Insert a new blade in the cleaver so that "1" of the number sticker is in the top position. The hole of the blade should be aligned with the hole of the blade receptacle.

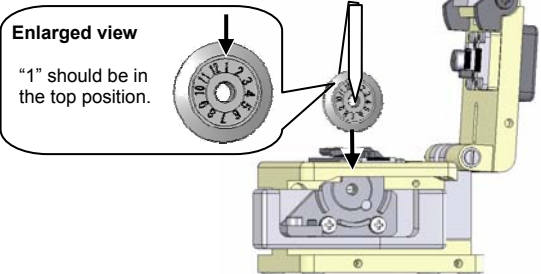

4: Tighten the blade setscrew completely, while pressing the side of the blade.
[Reference] Optimum torque: Approx. 0.98N·m (10kgf·cm)

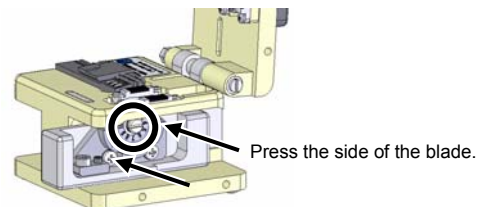

5: Adjust the blade height, referring to "Blade height adjustment" at page 2.

Troubleshooting



Good



Poor cleave angle



Lip



Crack

If the cleaving problem occurs, the followings are possible causes.

- (A) The fiber is placed obliquely in the cleaver.
→ Make sure that the fiber is placed straight in the cleaver.
- (B) The blade height is too high.
→ Adjust the blade height.
- (C) Dust or dirt remains on the clamp.
→ Clean the clamp.
- (D) Dust or dirt remains on the blade
→ Clean the blade.
- (E) Dust or dirt remains on the fiber.
→ Remove the fiber coating and clean the bare fiber again.

If the problem still persists, please contact our maintenance service center.

5. Fiber off-cut collector

Installing off-cut collector

- 1: Open the top clamp lever fully.
- 2: Put the lever pin into the pin hole of the cleaver and fit the hook into the cleaver.

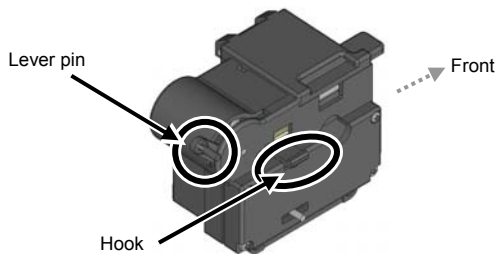

< Fiber off-cut collector CU-FC6 >

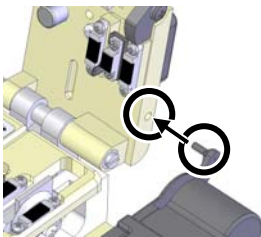

Put the lever pin into the pin hole of the cleaver.

Clip the hook from underneath the cleaver main body, as shown in the figure below.

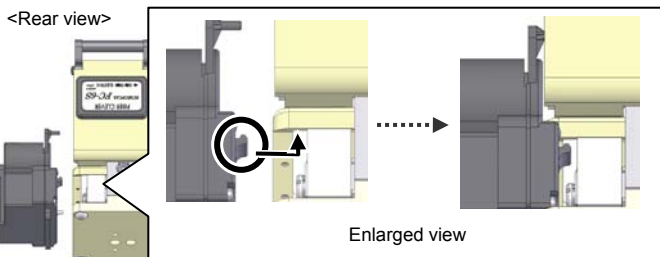

- 3: Ensure that the lever pin and hook fit the cleaver properly.

<Top view>

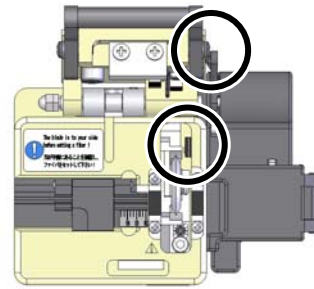

- 4: Align the screw holes on the cleaver with the screw holes on the off-cut collector.

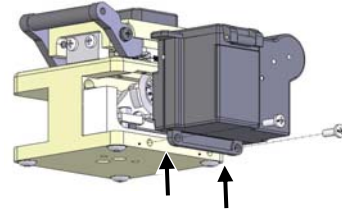

- 5: Tighten the 2 setscrews.

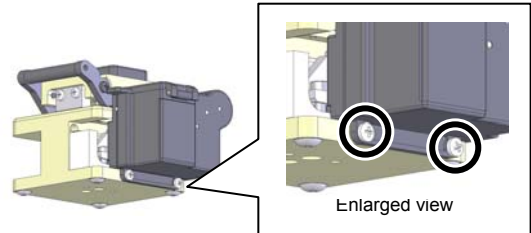

- 6: Completed.

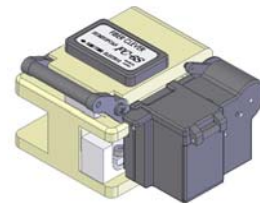

Emptying off-cut collector

- 1: Remove the off-cut bin from the off-cut collector and dispose of the off-cuts in a proper way.

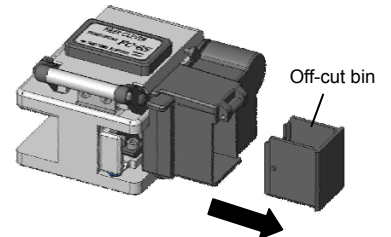

Tokyo (JAPAN)
Sumitomo Electric Industries, Ltd.
(Global Business Dept.)
3-9-1, Shibaura, Minato-ku, Tokyo
108-8539 JAPAN
Tel: +81 (0)3 6722 3246
<http://www.sei.co.jp>

Hong Kong
Sumitomo Electric Asia, Ltd.
Tel: +852 2576 0080

Beijing (China)
SUMIDEN ASIA (SHENZHEN) Co., Ltd.
(Beijing Branch)
Tel: +86 21 6235 1036

North Carolina (U.S.A.)
Sumitomo Electric Lightwave Corp.
78 Alexander Drive, P.O. Box 13445,
Research Triangle park,
NC27709 U.S.A
Tel: +1 919 541 8100
<http://www.sumitomoelectric.com>

Shanghai (China)
SUMIDEN ASIA (SHENZHEN) Co., Ltd.
(Shanghai Branch)
Tel: +86 21 6235 1036

London (U.K.)
Sumitomo Electric Europe Ltd.
220 Centennial Park, Centennial Avenue,
Elstree, Herts, WD6 3SL, U.K.
Tel: +44 (0)20 8953 8118
<http://www.sumielectric.com>

Guangzhou (China)
SUMIDEN ASIA (SHENZHEN) Co., Ltd.
(Guangzhou Branch)
Tel: +86 20 3877 2808

Bangkok (Thailand)
Sumitomo Electric (Thailand) Limited
Tel: +66 (0)2 260 7231 to 5

Singapore
Sumitomo Electric Interconnect
Products (Singapore) Pte Ltd.
Tel: +65 6261 3388

New Delhi (India)
Sumitomo Electric Industries, Ltd.
New Delhi Liason Office
Tel: +91 120 434 7701/7702

Philippines
Sumitomo Electric Industries
(Philippines) Incorporated
Tel: +63 2 811 2755/2756

(c) 2008 SUMITOMO ELECTRIC INDUSTRIES, LTD.